

# DAWN STRAIGHT LINE CLAMPS - PUSH & PULL ACTIONS

The straight line toggle clamps have a large holding capacity for its size. It is well adapted for use in confined areas because of its small package size and low height. The plunger can be locked in both the extended (open) or retracted (closed) clamping positions and can serve as latch clamps. The plunger comes with a threaded hole. Comes complete with oil resistant ergonomic handle. Additional mounting flanges can be supplied for models 602, 604 and 624 models. Stainless steel models available in 602-SS, 604-SS, 624-SS

Model	601-M	602-M	603-M	604-MM	605-M	607-M	624-M	606-M	609-M	610-M	620-M	630-M	640-M	650-M
Model s/steel	601-SS	602-SS		604-SS			624-SS							
Holding Force daN	40	90	270	130	130	360	300	200	130	270	270	1100	3000	4500
Stroke mm	16	19	32	38	32	42	67	38	32	41	28	50	101	76
Weight kgs	0.04	0.11	0.32	0.28	0.31	0.63	0.75	0.31	0.4	0.68	0.68	0.9	3.2	2.5

## Model 601-M

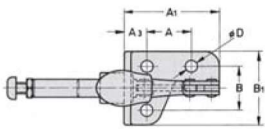
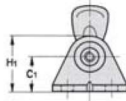
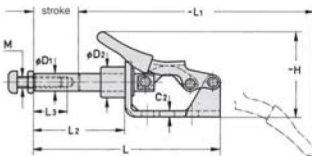

In stainless steel Model 601-SS

## Model 605-M

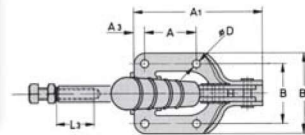
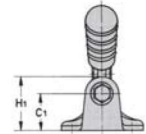
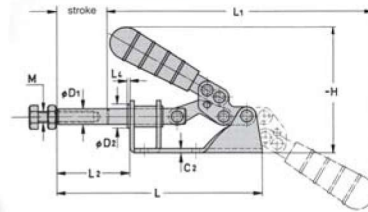

Model No.	A	A1	A3	B	B1	C1	C2	D	D1	D2	~H	H1	~L	~L1	L2	L3	L4	M
601-M	16	34	8	16	27	12.6	2.2	4.4	6.4	11	31	20	67	84	32.5	12	-	M4
605-M	35	87	7	41.3	55.5	24.5	3.2	5.5	11	19.5	90	37.5	139	195	49	25	2.5	M8

## Model 603-M

model 603-M

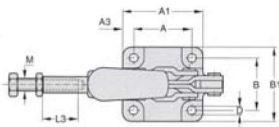
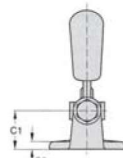
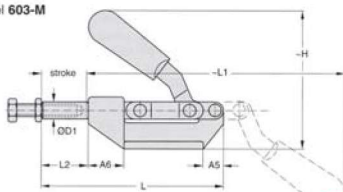

## Model 603-M

## Models 607 M, 630 M, 640 M

models 607-M, 607-SQM, 630-M and 640-M

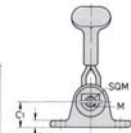
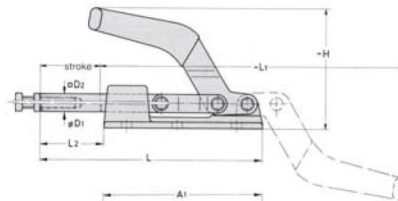

Special version available on request

Model 607-SQM with square push rod for accurate positioning. Same dimensions as model 607-M.



## Model 607-M



## Model 630-M



## Model 640-M

Model No.	A	A1	A2	A3	~A5	A6	B	B1	C1	C2	ØD	ØD1	D2	L	~L1	L2	L3	~H	M
603-M	36.6	51	-	7	10	24.5	33.2	48	24.5	5	5.5	11	-	121	167	32.5	25.4	88	M 8
607-M	35	107	76.5	15.5	-	-	41.5	56	17.5	5	7.2	12.7	-	154	212	47	25	85	M 8
607-SQM	35	107	76.5	15.5	-	-	41.5	56	17.5	5	7.2	-	12.7	154	212	47	25	85	M 8
630-M	35	128	76	13	-	-	41	57	21	5	8.7	16	-	180	234	52	32	75	M 10
640-M	90.5	216	181	17.5	-	-	54	76	32	9.5	10.3	22	-	321	393	105	50	110	M 12



**Model 602-MM**  
**604-MM**  
**624-MM**

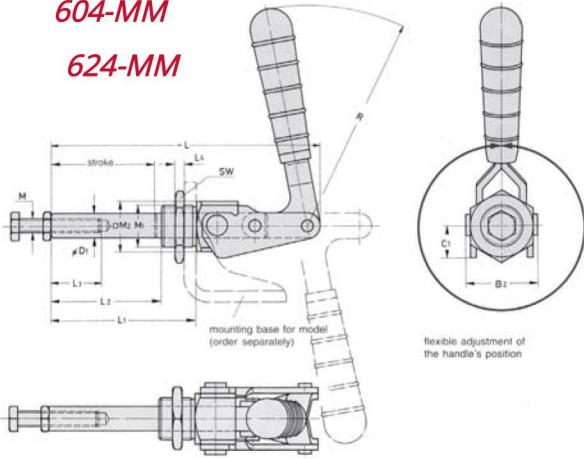

**mounting bases**  
for model 602-MM  
part no. **602106-M**  
(order separately)

for model 604-MM  
part no. **604106-M**  
(order separately)

for model 624-MM  
part no. **624106-M**  
(order separately)

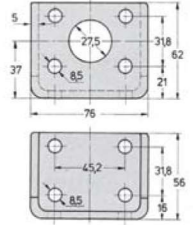
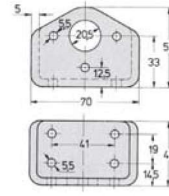
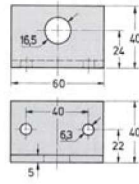

for model 604-MM  
part no. **604106-M**  
(order separately)



Model 604-MM

Model No.	B2	C1	ØD1	~L	L1	L2	~L3	L4	M	M1	M2	~R	SW
602-MM	26.5	11	9.5	62	33	20.5	15	6	M 6	M16 x 1.5	19	69	24
604-MM	33.5	11	11.1	110	56	40	25	6	M 8	M20 x 1.5	22	95	30
624-MM	48	20	16	170	92	70	32	6.5	M 10	M27 x 2	32	130	41

Recommended accessories  
(order separately)  
adjustment spindle

In stainless steel model : Models 602-SS, 604-SS, 624-SS

**Model 606 - M**  
Light duty version

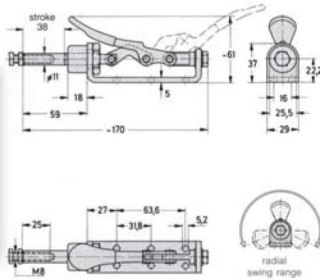
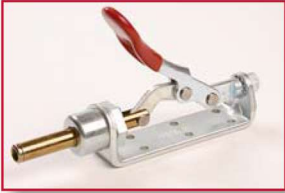

**Model 620 - M**

Medium duty version

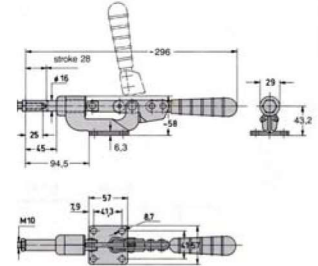

The handle and push rod move in opposite directions.  
The push rod does not lock in the open position.

The handle and push rod can be rotated. The push rod does not lock in the open position.

**Model 609 - M**

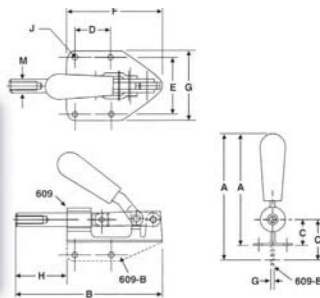

**Model 650 - M**

Heavy duty version

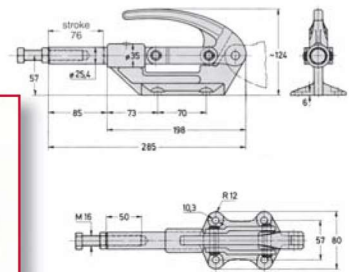

A	B	C	D	E	F	G	H	J	M
85.9	139.2	24.6	35.1	41.4	91.4	55.6	47.8	5.1	12.7

**Model 610 - M**

Medium duty version

